

Operation Manual of the Intelligent Controller

SR208C

for Split Pressurized Solar Hot Water System



Please read the instruction carefully before operation!

Contents

1.Safety information3

1.1 Installation and commissioning3

1.2 About this manual.....3

1.3 Liability waiver3

1.4 Important information3

1.5 Signal description4

1.6Button and HMI description4

2 Overview5

2.1 Technical data5

2.2 Delivery list.....5

3. Installation6

3.1 Mounting controller6

3.2 Wiring connection.....6

3.3 Terminal connection7

3.5 Connection with high efficiency pump8

4. System description (Standard solar system with 1 tank, 1 collector field)9

5. Function's parameters and options10

5.1 Overview of menu structure10

5.2 Menu operation description10

5.3 Value checking11

6. Functions operation and parameters setting (for user).....11

6.1 CLK Time setup.....11

6.2 AH Afterheating/thermostat function11

7. Function operation and parameter setup (engineer)14

7.1PWD Password14

7.2 LOAD tank heating15

7.3 COL Collector function17

7.4 PUMP Pump control mode	22
7.5 COOL Cooling function.....	24
7.6 MAN Manual operation.....	26
7.7 BLPR Blocking protection.....	26
7.8 OTDI Thermal Disinfection function.....	27
7.9 UNIT C-F Switch	28
7.10 BEEP Beeper fault warning	29
7.11 RET Reset	30
7.12 PASS Password setup	30
7.13 M.H Manual heating	31
7.14 Holiday function.....	31
8. Protection function.....	32
8.1 Memory function during power failure	32
8.2 Screen protection	32
8.3 Trouble checking	32
9. Quality Guarantee	33
10. Accessories	34

1. Safety information

1.1 Installation and commissioning

- When laying wires, please ensure that no damage occurs to any of the constructional fire safety measures presented in the building.
- The controller must not be installed in rooms where easily inflammable gas mixtures are present or may occur.
- The permissible environmental conditions can't be exceeded at the site of installation.
- Before connecting the device, make sure that the energy supply matches the specifications that controller requires.
- All devices connected to the controller must conform to the technical specifications of the controller.
- All operations on an open controller are only to be conducted cleared from the power supply. All safety regulations for working on the power supply are valid.
- Connecting and /or all operations that require opening the collector (e.g. changing the fuse) are only conducted by specialists.

1.2 About this manual

This manual describes the mounting, functions and operation of a solar controller used for a solar hot water system, for mounting of other devices of a completed solar hot water system like solar collector, pump station and storage, please is sure to observe the appropriate installation instructions provided by each manufacturer. Mounting, wire connecting, commissioning and maintenance of this controller may only be performed by the trained professional person; the professional person should be familiar with this manual and follow the instructions contained herein.

1.3 Liability waiver

The manufacturer can't monitor the compliance with these instructions or the circumstances and methods used for installation, operation, utilization and maintenance of this controller. Improper installation can cause damages to material and person. This is the reason why we do not take over responsibility and liability for losses, damages or cost that might arise due to improper installation, operation or wrong utilization and maintenance or that occurs in some connection with the aforementioned. Moreover we do not take over liability for patent infringements or infringements – occurring in connection with the use of this controller on the third parties rights. The manufacturer preserves the right to put changes to product, technical data or installation and operation instructions without prior notice. As soon as it becomes evident that safe operation is no longer possible (e.g. visible damage). Please immediate take the device out of operation. Note: ensure that the device can't be accidentally placed into operation.

1.4 Important information

We have carefully checked the text and pictures of this manual and provided the best of our knowledge

and ideas, however inevitable errors maybe exist. Please note that we cannot guarantee that this manual is given in the integrity of image and text, incorrect, incomplete and erroneous information and the resulting damage we do not take responsibility.

1.5 Signal description



Safety indication: Safety instructions in the text are marked with a warning triangle. They indicate measures which can lead to injury of person or safety risks.



Operation steps: small triangle “▶” is used to indicate operation step.

Notes: Contains important information about operation or functions.





1.6 Button and HMI description



➤ Controller is operated with the 6 buttons on the right side of the screen

- “” holiday button
- “M.H” button: manual heating
- “SET” button: confirm / selection
- “▲” up button: increase the value
- “▼” down button: reduce the value
- “ESC” button return/ exit : return to previous menu

Status description	Code	Lighting	Blinking
Exceed the maximum temperature of storage	SMX		
Running of storage emergency shutdown function			
Running of collector emergency shutdown function	CEM		+
Collector Cooling	OCCO		
Tank Cooling	OSTC		

System Cooling	OSYC		
Start of anti-freezing function	OCFR		
Running of anti-freezing function	OCFR		
Collector minimum temperature	OCMI		 Slow blink

2. Overview

2.1 Technical data

- **Inputs:** 1 * PT1000 temperature sensor input
2 * NTC10K, B=3950 temperature sensor input
1 * 485 communication port(Optional)
- **Outputs:** 1 * Electromagnetic relay, maximum current 2A
1 * Semiconductor relay, maximum current 1A
1* PWM variable frequency output (on/off switchable, 0-10V)
- **Functions:** operating hours counter, tube collector function, thermostat function, pump speed control, adjustable system parameters and optional functions (menu-driven), balance and diagnostics
- **Power supply:** 100...240V ~(50...60Hz)
- **Rated impulse voltage:** 2.5KV
- **485 current supply:** 60mA
- **Housing:** Plastic ABS
- **Mounting:** Wall mounting
- **Operation:** 6 push buttons at the front cover
- **Protection type:** IP41
- **Protection class:** I
- **Ambient temperature:** 0 ... 40 °C
- **Dimensions:** 178*120*43mm

2.2 Delivery list

- 1 * SR208C controller
- 1 * accessory bag
- 1 * user manual
- 1 * PT1000 temperature sensor (φ6*50mm,cable length 1.5meter)
- 2 * NTC10K temperature sensor (φ6*50mm,cable length 3meter)

3. Installation



Note: The unit must only be located in the dry interior rooms. Please separate routing of sensor wires and mains wires. Make sure the controller as well as the system is not exposed to strong electromagnetic fields.

3.1 Mounting controller

Follow the below steps to mount the controller on the wall.

- Unscrew the crosshead screw from the cover and remove it along with the cover from the housing.
- Mark the upper fastening point on the wall ①. Drill and fasten the enclosed wall plug and screw leaving the head protruding.
- Hang the housing from the upper fastening point and mark the lower fastening point ②.

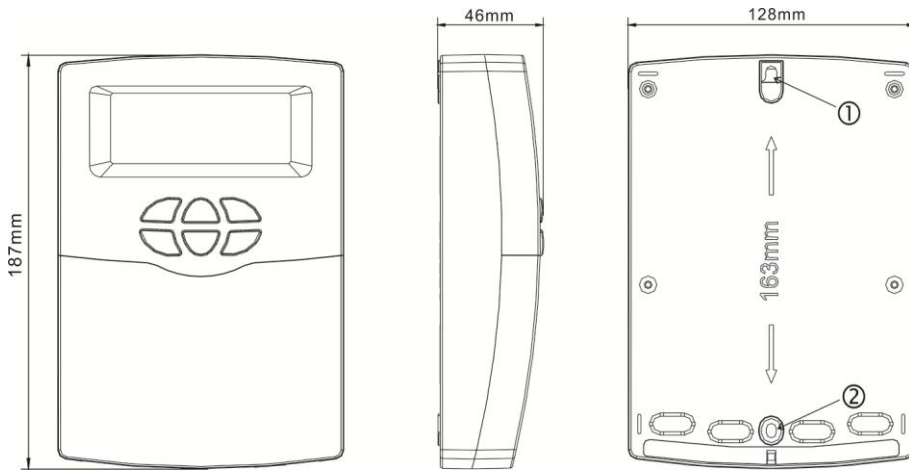

- Drill and insert lower wall plugs.
- Fasten the housing to the wall with the lower fastening screw and tighten.
- Carry out the electrical wiring in accordance with the terminal allocation
- Put the cover on the housing. Attach with the fastening screw.

3.2 Wiring connection

According to the way of installation, wire can be connected from hole ③ on the bottom plate or from hole ④, using a suitable tool (like knife) to cut the plastic of ③.



Note: wires must be fastened by fixing clamps on the terminal port.

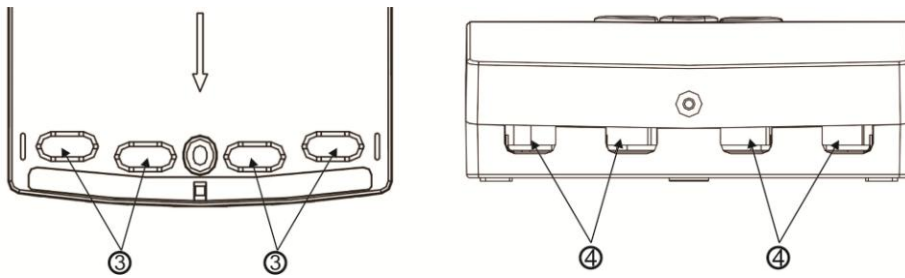

3.3 Terminal connection

⚠ Note: before opening the housing! Always disconnect the controller from power supply and obey the local electrical supply regulation.

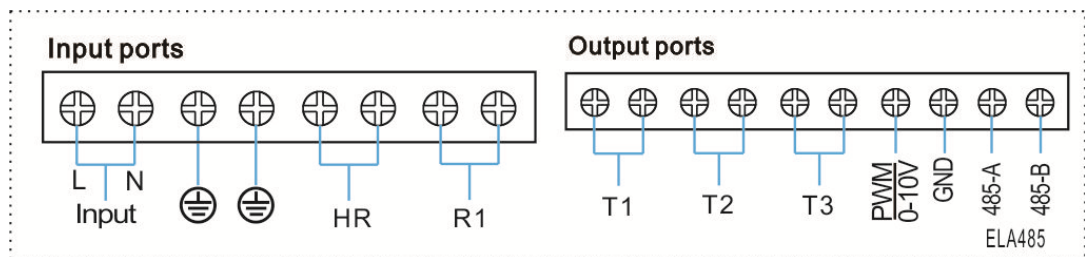

- **Input ports**
 - T1: PT1000 temperature sensor, for measuring the temperature of collector and thermal energy calculation.
 - T2 ~T3: NTC10K, B=3950 temperature sensor, for measuring temperature of tank and pipe.
 - Communication port 485 (selectable): ELA485, for remote control communication **(The Communication port not in the standard configuration;WIFI model should be purchased separately, detailed see annexed part)**
 - PWM: Signal ports for high efficiency pump, detailed connection see below
- **Advice regarding the installation of temperature sensors:**
 - Only original factory equipped Pt1000 temperature sensors are approved for using with the controller, it is equipped with 1.5m silicon cable and suitable for all weather conditions, the cable is temperature resistant up to 280°C, connect the temperature sensors to the corresponding terminals with either polarity.
 - Only original factory equipped NTC10K,B=3950 temperature sensors are approved for using with tank and pipe, it is equipped with 3m PVC cable, and the cable is temperature resistant up to 105°C, connect the temperature sensors to the corresponding terminals with either polarity.
 - All sensor cables carry low voltage, and to avoid inductive effects, must not be laid close to 230 volt or 400 volt cables (minimum separation of 100mm).
 - If external inductive effects are existed, e.g. from heavy current cables, overhead train cables,

transformer substations, radio and television devices, amateur radio stations, microwave devices etc., then the cables to the sensors must be adequately shielded.

- Sensor cables may be extended to a maximum length of ca. 100 meter, when cable's length is up to 50m, and then 0.75mm² cable should be used. When cable's length is up to 100m, and then 1.5mm² cables should be used.

● **Output ports**

Input Ports L, N: for power connection, L: live wire, N: zero wire,  protective wire

Output R1: Semiconductor relays (SCR), designed for pump speed control, Max. Current: 1A

Output HR: Electromagnetic relays, designed for on/off control of afterheating/thermostat function, Max. Current: 2A

3.5 Connection with high efficiency pump

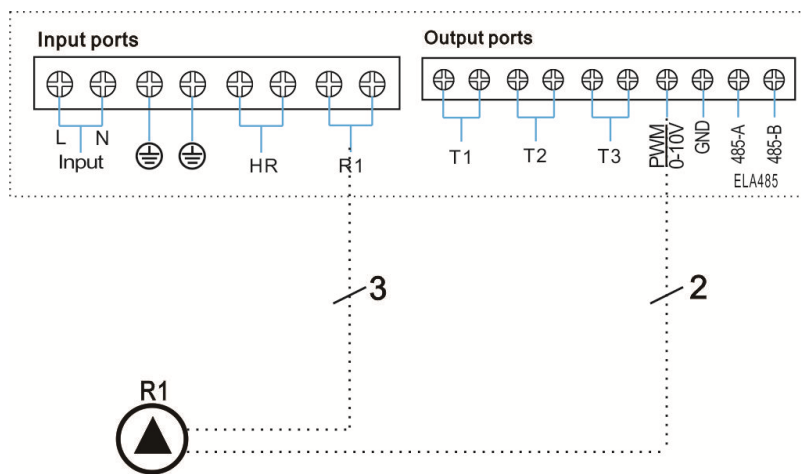

● **Connecting the signal wire from the high-efficiency pump**

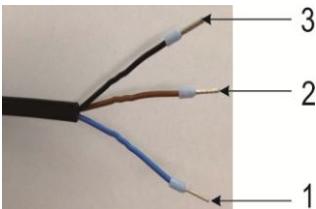

Signal	Overmoulded Pin	Cable color
PWM input (from controller)	1	Grey or blue
PWM common	2	brown
PWM output (from the pump)	3	black

Signal wire 1 from the high-efficiency pump is connected to GND port of controller

Signal wire 2 from the high-efficiency pump is connected to PWM port of controller

Signal wire 3 from the high-efficiency pump is not connected to the controller

 **Note:** High-efficiency pump with 0-10V signal only has 2 signal wires, connected to the corresponding port GND, PWM of controller.

4. System description (Standard solar system with 1 tank, 1 collector field)

Description:

The controller calculates the temperature difference between collector sensor T1 and tank sensor T2. If the difference is larger than or identical to the adjusted switch-on temperature difference, the solar circulation pump (R1) will be switched on and the tank will be loaded until the switch-off temperature difference or the maximum tank temperature is reached.

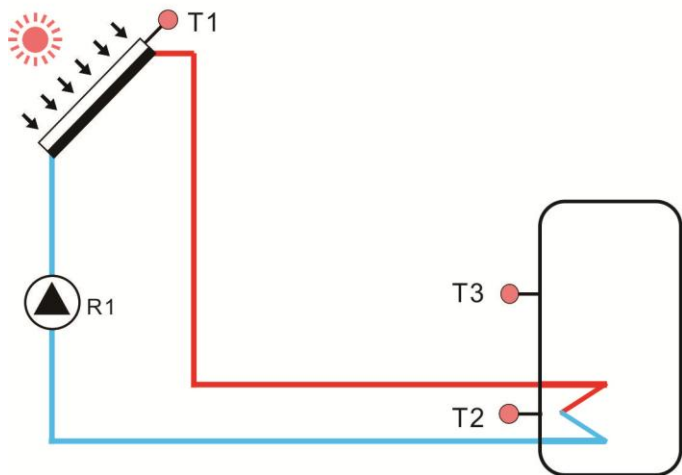
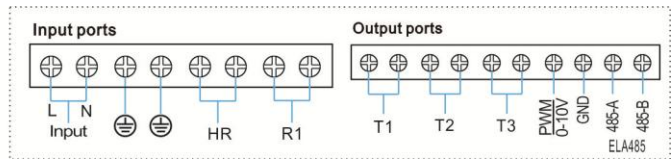
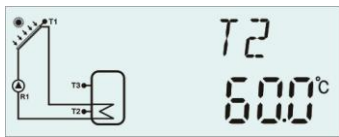

Sensor	Description	Relay	Description
T1	Temperature of collector	R1	Solar circulation pump
T2	Temperature of tank base	HR	Afterheating/thermostat function
T3	Temperature of tank upper		

5. Function's parameters and options

5.1 Overview of menu structure

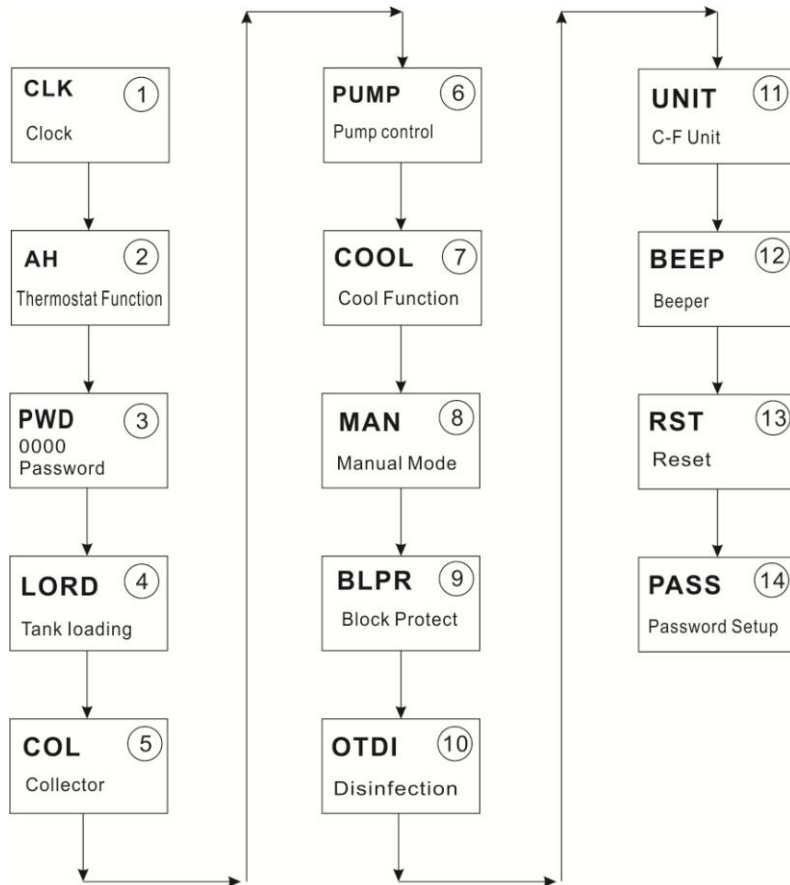

5.2 Menu operation description

- Access main menu
 - ▶ Press “SET” button to access main menu
 - ▶ Press “▲/▼” to select menu
 - ▶ Press “SET” button to enter the submenu

- Access submenu
 - ▶ After selecting main menu, then press “SET” button to access submenu
 - ▶ Press “▲/▼” button to select submenu,
 - ▶ Press “SET” button to enter the value adjust interface or selection function(select ON/OFF)
 - ▶ Press “▲/▼” to adjust value
 - ▶ Press “SET” to confirm the value you set

i **Note:** Enter the menu adjustment interface, if you don't press any button within 3 minutes, screen will exit the adjustment and turn to main interface.

5.3 Value checking

At the normal operation mode, press “▲/▼” button, you can view the temperature of collector and tank, pump speed, controller running time, software version.

i **Note:** enter the value check interface, if you don't press any button within 1 minutes, screen will exit the check interface and turn to main interface.

6. Functions operation and parameters setting (for user)

6.1 CLK Time setup



- ▶ Press “SET” button, select CLK menu
- ▶ Press “SET” button, hour “00” blinks on the display
- ▶ Press “▲/▼” button to adjust hour
- ▶ Press “SET” button, minute time “00” blinks on the display
- ▶ Press “▲/▼” button to adjust minute
- ▶ Press “SET” or “ESC” button to save the set value



i **Note:** In the case power to controller is switched-off, date and time will be remembered in controller for 36 hours.

6.2 AH Afterheating/thermostat function

The thermostat function works independently from the solar operation and can e. g. be used for using surplus energy or for afterheating.

• AH O < AH F

thermostat function for afterheating

• AH O > AH F

thermostat function for using surplus energy

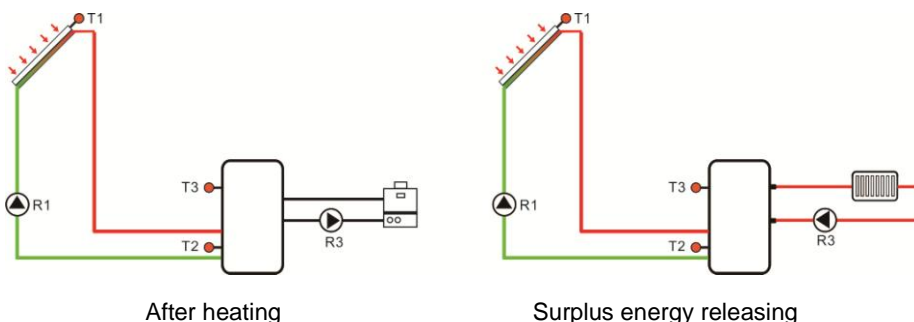

- In order to block the thermostat function for a certain period, there are 3 time frames t1 ... t3.
- The sensor(AHS) for “Afterheating/thermostat” is selectable.It’s controlled by tank’s sensor T3 or T2(selectable).
- If you want to shut off one timing heating ,then you can set the turning on time and turning off time same value(for example,set tA2 O 00:00 and set tA2 F 00:00,the second time section no this function),it’s mean this time section not available,afterheating/thermostat function OFF.
- Afterheating/thermostat function set:If the thermostat function is supposed to run from 06:00 a.m. and 05:00 p.m. only,adjust tA1O to 06:00 and tA1F to 17:00.

i Note: If customer use electrical heater as back-up, please according to the power of electrical heater to equip corresponding safety devices like contactor and breaker with this controller, we strongly recommend equipping with SR802 device with this controller, (SR802 detailed technical data see spare parts)

Main menu	Submenu	Factory set	Adjustable range	Step per adjust	Description
AH					Afterheating/thermostat function
	AHS	S2	S2. S3		Select desired sensor of heated tank (S3 for T3, S2

					for T2)
	AHO	40oC		0.5oC	Switch-on temperature of after heating
	AHF	45oC		0.5oC	Switch-off temperature of after heating
	tA 1O	00:00	00:00-23:59		Switch-on time of the first after heating
	tA 1F	23:59	00:00-23:59		Switch-off time of the first after heating
	t A2O	00:00	00:00-23:59		Switch-on time of the second after heating
	tA 2F	00:00	00:00-23:59		Switch-off time of the second after heating
	t A3O	00:00	00:00-23:59		Switch-on time of the third after heating
	t A3F	00:00	00:00-23:59		Switch-off time of the third after heating

Function setting:

▶ Press “SET” button to access main menu, and press “▲” to select AH Afterheating/thermostat main menu.

▶ Press “SET” button to set parameter, “AHS S2” displays on the screen.

▶ Press “SET” button, “S2” blinks

▶ Press “▲/▼” button to select desired sensor (S3 for T3, S2 for T2)

▶ Press “SET” or “ESC” button to save the setting.

▶ Press “▲” button, “AHO 40oC” displays on the screen

▶ Press “SET” button, “40oC” blinks

▶ Press “▲/▼” button to adjust the switch-on temperature.

▶ Press “SET” or “ESC” button to save the setting.

▶ Press “▲” button, “AHF 45oC” displays on the screen

▶ Press “SET” button, hour time “45oC” blinks

▶ Press “▲/▼” button to adjust hour of the switch-off temperature.

▶ Press “SET” or “ESC” button to save the setting.

▶ Press “▲” button “tA1O 00: 00” displays on the screen

▶ Press “SET” button, hour time “00” blinks

▶ Press “▲/▼” button to adjust hour of the switch-on time

▶ Press “SET” button, minute time “00” blinks

▶ Press “▲/▼” button to adjust minute of the switch-on time

▶ Press “SET” or “ESC” button to save the setting.

▶ Press “▲” button, “tA1F 23: 59” displays on the screen

▶ Press “SET” button, hour time “23” blinks

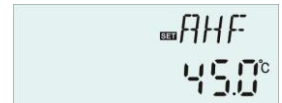

- ▶ Press “▲/▼” button to adjust hour of the switch-off time
- ▶ Press “SET” button, minute time “59” blinks
- ▶ Press “▲/▼” button to adjust minute of the switch-off time
- ▶ Press “SET” or “ESC” button to save the setting.
- ▶ Press “▲” button to access the window of the switch-on time of the second afterheating/thermostat, repeat above steps to set time for the second and third afterheating/thermostat.

If you want to shut of one time of afterheating/thermostat,you can set switch on and off at the same value.(For example,the second time section no this function,then you can set tA2O 00: 00 and tA2F 00: 00)

When heating sign (⦿) blinks on the screen, it indicates that after-heating function is activated.



Note:

The Sign" (⦿) " represents After-heating

1. Within the preset time section, heating sign (⦿) is lighted on the screen
2. Out of the preset time section, heating sign (⦿) doesn't display on the screen.

The Sign" AH " represents Thermostat

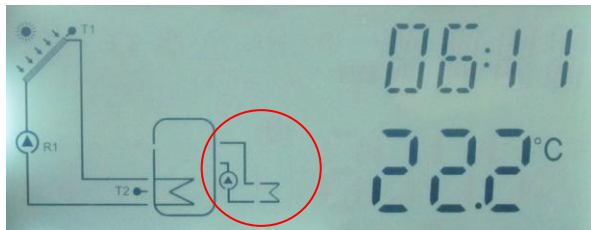

7. Function operation and parameter setup (engineer)

7.1 PWD Password

Menu structure

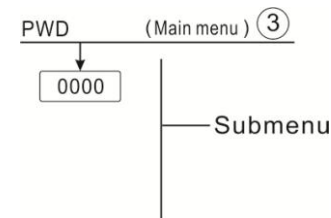

Access main menu, select “PWD 0000” to enter password

- ▶ Press “SET” button, the left digital blinks, enter password, factory set is “0000”
- ▶ Press “▲/▼”, to enter the first digital



- ▶ Press “SET”, the second digital blinks
- ▶ Press “▲/▼” to enter the second digital
- ▶ Press “SET”, the third digital blinks
- ▶ Press “▲/▼” to enter the third digital
- ▶ Press “SET”, the fourth digital blinks
- ▶ Press “▲/▼” to enter the fourth digital
- ▶ Press “SET”, to access main menu

Through password set to limit the user to change some parameters, 4 digitals needed. Default is 0000
If no password is set, then just press “SET” five times to access main menu directly

7.2 LOAD tank heating

Function description:

- **ΔT control logic**

The controller works as a standard temperature differential controller. If the temperature reaches or exceeds the switch-on temperature difference (DTO), the pump switches on. When the temperature difference reaches or falls below the adjusted switch-off temperature difference (DTF), the respective relay switches off.



Note: The switch-on temperature difference must be 0.5 K higher than the switch-off temperature difference. The set temperature difference must be at least 0.5 K higher than the switch-on temperature difference.

- **Speed control**

If the temperature reaches or exceeds the switch-on temperature difference, the pump switches on at 100% speed for 10s. Then, the speed is reduced to the minimum pump speed value.

If the temperature difference reaches the preset temperature difference, the pump speed increases by one step (10%). The response of the controller can be adapted via the parameter RIS. If the difference increases by the adjustable rise value RIS, the pump speed increases by 10% until the maximum pump speed of 100% is reached. If the temperature difference decreases by the adjustable rise value (RIS), pump speed will be decreased by one step 10% accordingly.



Note: To enable speed control function, the corresponding pump has to be set to (MIN, MAX) and relay control has to be set to (PULS, PSOL, PHEA or 0-10 V) (under adjustment menu PUMP).

- **SMX Maximum tank temperature protection set**

If the tank temperature reaches the adjusted maximum temperature, the tank will no longer be loaded in order to avoid damage caused by overheating. If the maximum tank temperature is exceeded, sign  is displayed on the screen.

The sensor for tank maximum limitation (SMAX) can be selected. The maximum limitation always refers to the sensor selected (T2 or T3). The switch-on hysteresis (HYST) is selectable(Default is 2°C), for example, when tank maximum temperature is set to 70°C, then at 68 °C, Maximum tank temperature protection function is deactivated automatically.

Menu Structure					
Main menu	Submenu	Factory set	Adjustable range	Step per adjust	Description
LOAD					Tank heating
	DTO	6K	1-50K	0.5K	Switch-on temperature difference of tank heating
	DTF	4K	0.5-49.5K	0.5K	Switch-off temperature difference of tank heating
	DTS	10K	1.5-50K	0.5K	Temperature difference of pump speed control
	RIS	2K	1-20K	1K	Rise range of pump speed control
	SMX	70°C	4-95°C	1°C	Maximum temperature of tank
	SMAX	S2	S2. S3		Sensor for Maximum temperature of tank (S3 for T3, S2 for T2)
	HYST	2K	0.1-10K	0.1K	Hysteresis of maximum temperature of tank

Setup the functions

- ▶ Select “LOAD” main menu
- ▶ Press “SET”, “DTO 6K” displays on the screen
- ▶ Press “SET”, “6K” blinks



- ▶ Press “▲/▼”, to adjust the switch-on temperature of the solar circuit pump
- ▶ Press “SET” or “ESC” to save the setting
- ▶ Press “▲”, “DTF 4K” displays on the screen
- ▶ Press “SET”, “4K” blinks
- ▶ Press “▲/▼”, to adjust the switch-off temperature of solar circuit pump
- ▶ Press “SET” or “ESC” to save the setting



- ▶ Press “▲”, “DTS 10K” displays on the screen
- ▶ Press “SET”, “10K” blinks
- ▶ Press “▲/▼”, to adjust the standard temperature difference of solar circuit pump
- ▶ Press “SET” or “ESC” to save the setting
- ▶ Press “▲”, “RIS 2K” displays on the screen
- ▶ Press “SET”, “2K” blinks
- ▶ Press “▲/▼”, to adjust the rise range of pump speed control
- ▶ Press “SET” or “ESC” to save the setting



- ▶ Press “▲”, “RIS 2K” displays on the screen
- ▶ Press “SET”, “2K” blinks
- ▶ Press “▲/▼”, to adjust the rise range of pump speed control
- ▶ Press “SET” or “ESC” to save the setting





- ▶ Press “▲”, “SMX 70°C” displays on the screen
- ▶ Press “SET”, “70°C” blinks
- ▶ Press “▲/▼”, to adjust the maximum temperature of tank
- ▶ Press “SET” or “ESC” to save the setting
- ▶ Press “▲”, “SMAX S2” displays on the screen
- ▶ Press “SET”, “S2” blinks
- ▶ Press “▲/▼”, select the sensor for maximum temperature of tank (S3 for T3, S2 for T2)
- ▶ Press “SET” or “ESC” to save the setting
- ▶ Press “▲”, “HYST 2K” displays on the screen
- ▶ Press “SET”, “2K” blinks
- ▶ Press “▲/▼”, to adjust the hysteresis of tank maximum temperature
- ▶ Press “SET” or “ESC” to save the setting



7.3 COL Collector function

Function description

- **OCEM Collector emergency shutdown**

When the collector temperature exceeds the adjusted collector emergency temperature, Then solar pump (R1) switches off in order to protect the system components against overheating (collector emergency shutdown). If the maximum collector temperature (OCEM) is exceeded, sign   is displayed.

 **Warning!** Risk of injury! Risk of system damage by pressure surge! If water is used as the heat transfer fluid in pressure systems, water will boil at 100 °C. Then do not set the collector limit

temperature higher than 95 °C.

- **OCCO Collector cooling**

The collector cooling function keeps the collector temperature rising within the operating range by heating the tank. If the tank temperature reaches 95°C the function will be switched off for safety reasons.

When the tank temperature exceeds the adjusted maximum temperature of tank, then solar system is switched off. If the collector temperature rises up to its adjusted maximum collector temperature, the solar pump is switched on again until the collector temperature falls below the maximum collector temperature. The tank temperature may then exceed its maximum temperature, but only up to 95°C (emergency shutdown of the tank), and sign  blinks on the screen, system stops.

If the collector cooling is active,  blinks on the screen.

This function is only available when the system cooling function (OSYC) and the heat transfer function (OHDP) are not activated.

- **OCMI Collector minimum temperature**

The minimum collector temperature is the lowest temperature of collector, only when collector temperature is higher than that temperature, solar pump (R1) just can be switched-on, if the collector temperature falls below the adjusted minimum temperature, the function is activated,  slow blinks on the screen.

- **OCFR Collector antifreeze function**

Collector antifreeze function activates the loading circuit between the collector and the tank when the collector temperature falls below the adjusted temperature **CFRO**. This will protect the fluid against freezing or coagulating. If collector temperature exceeds the switch-off temperature of collector antifreeze function CFRF, the solar pump will be switched off again.

If collector antifreeze function is activated, sign  slow blinks on the screen.



Note: Since this function uses the limited heat which is saved in the tank, so the antifreeze function should be used in regions where ambient temperatures is around the freezing point only for a few days.

- **OTCO Tube collector function**

This function is used for improving the switch-on behavior in systems with non-ideal sensor positions (e. g. with some tube collectors).

This function operates within an adjusted time section. It activates the collector circuit pump R1 for an adjustable runtime between adjustable pauses in order to compensate for the delayed temperature

measurement.

If the runtime is set to more than 10s, the pump will run at 100% for the first 10s of the runtime. For the remaining runtime, the pump will run at the adjusted minimum speed.

If the collector sensor is defective or the collector is blocked, this function will be switched off.

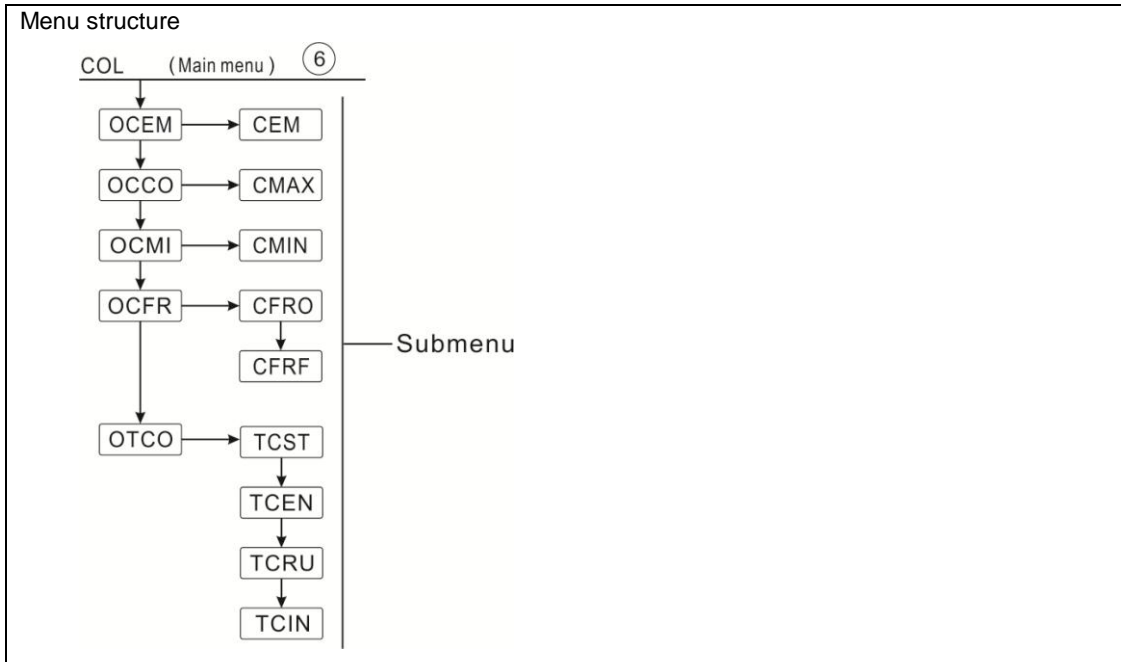

Main menu	Submenu 1	Submenu 2	Factory set	Adjustable range	Step per adjust	Description
COL						Collector function
	OCEM		ON			Collector emergency shutdown function on/ff
		CEM	130°C	80-200°C	1°C	Temperature of collector emergency shutdown(hysteresis 10K)
	OCCO		OFF			Collector cooling function on/off
		CMAX	110°C	70-160°C	1°C	Temperature of collector cooling (hysteresis 5°C)
	OCMI		OFF			Collector minimum temperature function on/off
		CMIN	10°C	10-90°C	1°C	Temperature of collector minimum function

	OCFR		OFF			Anti-freeze function on/off
		CFRO	4°C	-40-8°C	0.5°C	Switch-on temperature of anti-freeze function
		CFRF	5°C	-39-9°C	0.5°C	Switch-off temperature of anti-freeze function
	OTCO					Tube collector function
		TCST	07:00	00:00-23:00	1min	Start time of tube collector function
		TCEN	19:00	00:00-23:00	1min	Stop time of tube collector function
		TCRU	30s	30-300s	1s	Pump runtime during tube collector function
		TCIN	30min	5-60min	1min	Pump stop time during tube collector function

Function setting:

OCEM (Collector emergency shutdown function) setup

- ▶ Select "COL" function menu
 - ▶ Press "SET", "OCEM" displays on the screen
 - ▶ Press "SET" again, "OCEM ON" displays on the screen
 - ▶ Press "SET", "ON" blinks on the screen
- (If it is necessary to shut down this function, press "▲/▼" to deactivate it)
- ▶ Press "SET" or "ESC" to save the setting
 - ▶ Press "▲", "OCEM 130°C" displays on the screen
 - ▶ Press "SET", "130°C" blinks on the screen
 - ▶ Press "▲/▼", to activate or deactivate the collector emergency function
 - ▶ Press "SET" or "ESC" to save the setting
 - ▶ Press "ESC" to return to previous menu



OCCO (Collector cooling function) setup

- ▶ Press "▲", "OCCO" displays on the screen
 - ▶ Press "SET", "OCEM OFF" displays on the screen
 - ▶ Press "SET", "OFF" blinks on the screen
- ▶ Press "▲/▼", to activated this function, "OCEM ON" displays on the screen
- ▶ Press "▲", "CMAX 110°C" displays on the screen



- ▶ Press “▲/▼”, to adjust the switch-on temperature of collector cooling function
- ▶ Press “SET” or “ESC” to save the setting
- ▶ Press “ESC” to return to previous menu

OCMI (Collector minimum temperature) setup

- ▶ Press “▲”, “OCMI” displays on the screen
- ▶ Press “SET”, “OCMI OFF” displays on the screen
- ▶ Press “SET”, “OFF” blinks on the screen
- ▶ Press “▲/▼”, to activate this function, “OCMI ON” displays on the screen
- ▶ Press “▲”, “OCMI 10°C” displays on the screen
- ▶ Press “▲/▼”, to adjust the minimum temperature of collector
- ▶ Press “SET” or “ESC” to save the setting
- ▶ Press “ESC” to return to previous menu



OCFR (Antifreeze function) setup

- ▶ Press “▲”, “OCFR” displays on the screen
- ▶ Press “SET”, “OCFR OFF” displays on the screen
- ▶ Press “SET”, “OFF” blinks on the screen
- ▶ Press “▲/▼”, to activate this function, “OCFR ON” displays on the screen
- ▶ Press “▲”, “CFRO 4°C” displays on the screen
- ▶ Press “SET”, “4°C” blinks on the screen
- ▶ Press “▲/▼”, to adjust the switch-on temperature of antifreeze function
- ▶ Press “SET” or “ESC” to save the setting
- ▶ Press “▲”, “CFRF 5°C” displays on the screen
- ▶ Press “SET”, “5°C” blinks on the screen
- ▶ Press “▲/▼”, to adjust the switch-off temperature of antifreeze function
- ▶ Press “SET” or “ESC” to save the setting
- ▶ Press “ESC” to return to previous menu



OTCO (Tube collector function) setup

- ▶ Press “▲”, “OTCO” displays on the screen
- ▶ Press “SET”, “OTCO OFF” displays on the screen
- ▶ Press “SET”, “OFF” blinks on the screen
- ▶ Press “▲/▼”, to activated this function, “OTCO ON” displays on the screen
- ▶ Press “▲”, “TCST 07:00” displays on the screen



- ▶ Press “SET”, “07” blinks
- ▶ Press “▲/▼”, to adjust hour
- ▶ Press “SET”, “00” blinks on the screen
- ▶ Press “▲/▼”, to adjust minute
- ▶ Press “SET” or “ESC” to save the setting
- ▶ Press “▲”, “TCEN 19:00” displays on the screen
- ▶ Press “SET”, “19” blinks
- ▶ Press “▲/▼” to adjust hour
- ▶ Press “SET”, “00” blinks
- ▶ Press “▲/▼”, to adjust minute
- ▶ Press “SET” or “ESC” to save the setting
- ▶ Press “▲”, “TCRU 30” displays on the screen
- ▶ Press “SET”, “30” blinks
- ▶ Press “▲/▼”, to adjust runtime
- ▶ Press “SET” or “ESC” to save the setting
- ▶ Press “▲”, “TCIN 30Min” displays on the screen
- ▶ Press “SET”, “30” blinks
- ▶ Press “▲/▼”, to adjust stop time
- ▶ Press “SET” or “ESC” to save the setting
- ▶ Press “ESC” to return to previous menu



7.4 PUMP Pump control mode

Function description:

With this parameter, the relay control mode can be adjusted. The following modes can be selected:

- Adjustment for standard pump without speed control:
 - ONOF: Pump on / pump off
- Adjustment for standard pump with speed control:
 - PULS: Burst control via semiconductor relay
- Adjustment for high-efficiency pump (HE pump)
 - PSOL: PWM profile solar pump
 - PHEA: PWM profile heating pump
 - 0-10: Speed control via 0 - 10 V signal



Note:

1. More information about connection of high efficiency pump see the paragraph (3.5 Connection with high efficiency pump)
2. Minimum pump speed: Under the adjustment menu MIN1 , a relative minimum speed for connected pumps can be allocated to the outputs R1.
3. Maximum pump speed: Under the adjustment menu MAX1, a relative maximum speed for

connected pumps can be allocated to the outputs R1.

- When the devices which are not speed-controlled are used (e. g. motored valves), the pump speed value of the corresponding relay must be set to 100 % or the control Mode must be set to ONOF in order to deactivate pump speed control.



Note: PWM Relay allocation: PWM for R1

Main menu	Submenu 1	Submenu 2	Factory set	Adjustable range	Step per adjust	Description
PUMP						Pump control mode
	ONOF		ON	ON/OFF		Pump on/off (for pump without speed adjustment function)
	PULS		OFF	ON/OFF		Pulse control (Burst control via semiconductor relay)
		MIN1	50%	20-95%	5%	
		MAX1	100%	25-100%	5%	
	PSOL		OFF	ON/OFF		PWM profile solar pump
		MIN1	50%	20-95%	5%	
		MAX1	100%	25-100%	5%	
	PHEA		OFF	ON/OFF		PWM profile heating pump
		MIN1	50%	20-95%	5%	
		MAX1	100%	25-100%	5%	
	0-10		OFF	ON/OFF		0-10V signal control pump speed
		MIN1	50%	20-95%	5%	
		MAX1	100%	25-100%	5%	

Function setup

- ▶ Select "PUMP" menu
- ▶ Press "SET", "ONOF ON" displays on the screen
- ▶ Press "▲/▼", to select pump type "PLUS、PSOL、PHEA、0-10V"
- ▶ After select pump type, press "SET" to access the pump type.
- ▶ Press "SET", "OFF" blinks on the screen
- ▶ Press "▲/▼" to open
- ▶ Press "SET" or "ESC" to save the setting
- ▶ Press "ESC" to return to previous menu



 **Note:**

Only 1 type can be selected from 5 types ONOF、PLUS、PSOL、PHEA、0-10V

Example: when “PLUS ON” open option is selected, then other four types are closed automatically.

7.5 COOL Cooling function

Function description:

There are 3 cooling functions can be activated for 3 different devices: system cooling, tank cooling, heat transferring by external radiator.

- **OSYC System cooling**

The system cooling function aims to keep the lifetime of a solar system for a longer time. The function overrides the maximum tank temperature to provide thermal relief of the collector field and the heat transfer fluid on hot days. If the tank temperature is higher than the adjusted maximum tank temperature and the switch-on temperature difference **DTCO** is reached, the solar pump remains running or will be switched on. Solar loading is continued until either the temperature difference falls below the adjusted switch-off value **DTCF** or the collector emergency shutdown temperature **CEM** is reached.



Note: This function will only be available when the collector cooling function, external radiator heat transfer functions are not activated.

- **OSTC Tank cooling**

When the tank cooling function is activated, the controller aims to cool down the tank during the night in order to prepare it for solar loading on the following day. If the tank temperature exceeds the adjusted maximum tank temperature **SMAX**, the collector temperature falls below the tank temperature and down to the switch-on temperature difference **DTCO** of this cooling function, then system will be activated in order to cool down the tank by releasing the energy through the collector.

If tank cooling function is activated, sign  blinks on the screen



Note: if tank temperature reaches to 95 °C, all cooling functions will be locked. Hysteresis switch on temperature difference is 5K.

Main menu	Submenu 1	Submenu 2	Factory set	Adjustable range	Step per adjust	Description
COOL						Cooling function
	OSYC		OFF	ON/OFF		System cooling function
	OSTC		OFF	ON/OFF		Tank cooling function
		DTCO	20K	1-30K	0.5K	Switch-on temperature difference of cooling function
		DTCF	15K	0.5-29.5K	0.5K	Switch-off temperature difference of cooling function

Function setting:

OSYC (system cooling function) setting

- ▶ Select “COOL” menu
- ▶ Press “SET”, “OSYC OFF” displays on the screen
- ▶ Press “SET”, “OFF” blinks on the screen
- ▶ Press “▲/▼”, to activate this function
- ▶ Press “SET” or “ESC” to save the setting



OSTC (Tank cooling function) setting

- ▶ Press “▲” button, “OSTC” displays on the screen
- ▶ Press “SET”, “OSTC OFF” displays on the screen
- ▶ Press “SET” button, “OFF” blinks
- ▶ Press “▲/▼” to activate this function
- ▶ Press “▲”, “DTCO 20K” displays on the screen
- ▶ Press “SET”, “20K” blinks
- ▶ Press “▲/▼”, to adjust the switch on temperature difference
- ▶ Press “SET” or “ESC” to save the setting
- ▶ Press “▲”, “DTCF 15K” displays on the screen



- ▶ Press “▲/▼”, to adjust the switch-off temperature difference
- ▶ Press “SET” or “ESC” to save the setting
- ▶ Press “ESC” to return to previous menu

7.6 MAN Manual operation

For control and service work, the operating mode of the relays can be manually adjusted. For this purpose, select the adjustment menu MAN (for R1, HR) to set output “On/OFF” Manually.

i **Note:** When manual mode is activated, sign (M) blinks on the screen, controller runs for 15 minutes and then switch-off all output, control exits manual mode automatically.

Main Menu	Submenu	Factory set	Adjustable range	Description
MAN				Manual mode
	R1	OFF	ON/OFF	R1 on and off
	HR	OFF	ON/OFF	HR on and off

Function setup

- ▶ Press “▲”, “R1” displays on the screen
- ▶ Press “SET”, “R1 OFF” displays
- ▶ Press “SET”, “OFF” blinks
- ▶ Press “▲/▼”, to activate this function, “R1 ON” displays
- ▶ Press “SET” or “ESC” to save the setting
- ▶ Press “▲”, “HR” displays, repeat above steps to set the manual output of HR.



7.7 BLPR Blocking protection

Function description:

In order to protect the pumps against blocking after standstill, the controller is equipped with a blocking protection function. This function switches on the relays one after another every day at 12:00 a.m and pump runs for 10s at 100 % speed.

Menu structure			
BLPR (Main menu) ⑨ 			
Main Menu	Submenu	Factory set	Description
BLPR	ON/OFF	OFF	

Function setting

- ▶ Press “▲”, “BLPR” displays on the screen
- ▶ Press “SET”, “BLPR OFF” displays
- ▶ Press “SET”, “OFF” blinks
- ▶ Press “▲/▼”, to activate this function, “BLPR ON” displays on the screen
- ▶ Press “SET” or “ESC” to save the setting



7.8 OTDI Thermal Disinfection function

Function description:

This function helps to prevent the spread of Legionella in DHW tanks by systematically activating the after-heating.

For thermal disinfection, the temperature at the allocated sensor has to be monitored. During the monitoring period PDIS, this protection ensures the disinfection temperature is continuously exceeded the disinfection temperature TDIS for the entire disinfection period DDIS. Thermal disinfection can only be completed when the disinfection temperature is exceeded for the duration of the disinfection period without any interruption.

The monitoring period PDIS starts as soon as the temperature at the allocated sensor falls below the disinfection temperature TDIS, once the monitoring period PDIS ends, disinfection period SDIS starts, and the allocated reference relay activates the after-heating, when tank temperature exceeds the disinfection temperature, disinfection phase DDIS starts and disinfection heating time countdowns, countdown finishes, disinfection heating finishes.

Menu structure	
OTDI (Main menu) ⑩ 	

Menu	Submenu	Factory set	Adjustable range	Step per adjust	Description
OTDI		OFF	ON/OFF		Disinfection function
	PDIS	7d	0-30d	1d	Time section of disinfection monitoring
	DDIS	10min	1-180	1min	Heating time of disinfection
	TDIS	70°C	0-90°C	1°C	Temperature of disinfection
	SDIS	18:00	00:00-21:00	1:00	Start time of disinfection

Function setting

- ▶ Press “▲”, “OTDI” displays on the screen
- ▶ Press “SET”, “OTDI OFF” display
- ▶ Press “SET”, “OFF” blinks
- ▶ Press “▲/▼”, to activate this function, “OTDI ON” displays
- ▶ Press “SET” or “ESC” to save the setting
- ▶ Press “▲”, “PDIS 7” displays
- ▶ Press “SET”, “7” blinks
- ▶ Press “▲/▼”, to adjust the days for disinfection monitoring,
- ▶ Press “SET” or “ESC” to save the setting
- ▶ Press “▲”, “DDIS 10Min” displays on the screen
- ▶ Press “SET”, “10” blinks
- ▶ Press “▲/▼”, to adjust the heating time of disinfection
- ▶ Press “SET” or “ESC” to save the setting
- ▶ Press “▲”, “TDIS 70°C” displays on the screen
- ▶ Press “SET”, “70°C” blinks
- ▶ Press “▲/▼”, to adjust the temperature of disinfection
- ▶ Press “SET” or “ESC” to save the setting
- ▶ Press “▲”, “SDIS 18:00” displays on the screen
- ▶ Press “SET”, “18” blinks
- ▶ Press “▲/▼”, to adjust the start time of the disinfection
- ▶ Press “SET” or “ESC” to save the setting



7.9 UNIT C-F Switch



Main Menu	Submenu	Factory set	Adjustable range	Description
UNIT				Unit switch menu
	TEMP	°C	°C / °F	°C – °F switch

Function setting

- ▶ Select UNIT menu
- ▶ Press “SET”, “TEMP °C” displays on the screen
- ▶ Press “SET”, “°C” blinks
- ▶ Press “▲/▼”, to select temperature unit
- ▶ Press “SET” or “ESC” to save the setting



7.10 BEEP Beeper fault warning

When system has fault(temperature sensor fault,beep will send warning,it's will exist the fault warning after you press"ESC" button.

Menu structure			
<p>BEEP (Main menu) ⑫</p> <pre> graph TD BEEP --- ONOFF[ON/OFF] BEEP --- Submenu </pre>			
Main Menu	submenu	Factory set	Description
BEEP	ON/OFF	OFF	Beeper fault warning switch ON/OFF

BEEP(Beeper fault warning function) Setting

- ▶ Press “SET”, “BEEP” display on the screen.
- ▶ Press “SET”, “BEEP OFF” display on the screen.
- ▶ Press “SET”, “OFF” blink on the screen.
- ▶ Press“▲/▼”button, to switch on the function, “BEEP ON” display on the screen.
- ▶ Press “SET” or “ESC”to save the setting.



7.11 RET Reset

By means of the reset function, all adjustments can be reset to the factory settings.

Menu structure

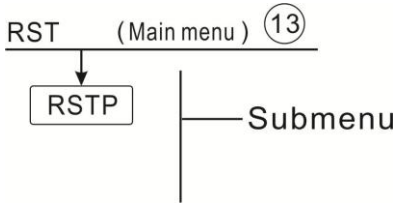

Function setting

- ▶ Select RST menu
- ▶ Press “SET”, “RSTP” displays on the screen
- ▶ Press “SET”, “YES” blinks
- ▶ Press “SET” for 3 seconds, beeper sounds “di” 3 times, “YES” lighting, and it indicates system is recovered to factory set.
- ▶ Press “ESC” return to the submenu



7.12 PASS Password setup

Function description:

This function helps to customers to set up new password.

Menu structure

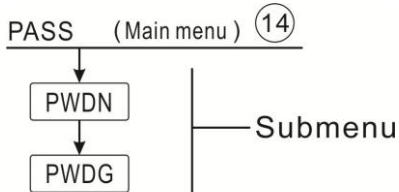

Function Setting

Select the password setting, “PASS” menu

To access main menu PASS,

- ▶ Press “SET” button, “PWDN 0000” appears,
- ▶ Press “SET” button, the left digital blinks, ask for entering current password, factory set is “0000”
- ▶ Press “▲/▼”, button to enter the first digital
- ▶ Reprress “SET” button, the second digital blinks
- ▶ Press “▲/▼”, button to enter the second digital
- ▶ Reprress “SET” button, the third digital blinks

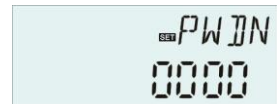

- ▶ Press “▲/▼”, button to enter the third digital
- ▶ Repress “SET” button, the fourth digital blinks
- ▶ Press “▲/▼”, button to enter the fourth digital
- ▶ Press “SET” button, “PWDG 0000” displays on the screen, ask for reentering the new password, doing like above to reenter the new password, “OK” displays on the screen to indicate reentering password successfully.



i **Note:** If the password is forgot, it is impossible to recover, but you can recover the password to factory set, then you can reedit a password like above descript steps, doing like following to recover to factory set.



- ▶ Switch-off the power to controller
- ▶ Hold down “ESC” button
- ▶ Reconnect the power supply, when beeper sounds 3 di....., and then release “ESC” button, Controller recovers to the factory set password (factory set password is 0000),

7.13 M.H Manual heating

Function Description:

It is possible to trigger back-up heating manual with this controller to heat tank. When tank temperature is lower than the set point of the switch-on temperature, manual heating function is in standby, when you press the manual heating button, heating will start, and it works until tank temperature reaches to the set point.

Activate/deactivate this function:

- ▶ Press “M.H” button , temperature “60°C” blinks on the screen
- ▶ Press “▲/▼”, to adjust the desired temperature, adjustable range 10°C–80°C, factory set is 60°C
- ▶ Press “M.H” or “ESC” or waiting for 20 seconds to trigger the manual heating, then manual sign  displays on the screen, heating sign  blinks the screen
- ▶ Press “M.H” again, switch-off manual heating.



i **Note:** 1).Manual heating is not a continuous heating process, it is triggered manually, and when the temperature reaches to the set point, the heating process is stopped. And manual heating function is stopped automatically.

2).AHO>AHF: Thermostat function for using surplus energy, manual heating is not available.

7.14 Holiday function

The holiday function is used for operating the system when no water consumption is expected, e. g. during a holiday absence. This function cools down the system in order to reduce the thermal load. When bottom temperature of tank below down 35°C, the solar pump is deactivate.

Activate/deactivate this function:

- ▶ Press “  ” button for 3 seconds, “HDAY 05” displays on the screen
- ▶ Press “▲/▼”, to adjust holiday’s days, adjustable range 0-99 days
- ▶ Press “  ” for 3 seconds again, to adjust holiday’s days to 0,
- ▶ Press “ESC” to exit, holiday function is closed

 **Note:** When you return from holiday, please deactivate this function in time.

8. Protection function

8.1 Memory function during power failure

When power of controller is failed, and when power is switched-on, controller will keep the parameters which set before power failure.

8.2 Screen protection

When no any press on button for 5 minutes, screen protection is activated automatically, and then LED background lamp is switched-off. Through press any button to light LED lamp again.

8.3 Trouble checking

The built-in controller is a qualified product, which is conceived for years of continuous trouble-free operation. If a problem occurs, the most of causes is from the peripheral components but no relation with controller itself. The following description of some well-known problems should help the installer and operator to isolate the problem, so that the system can be put into operation as quickly as possible and to avoid unnecessary cost. Of course, not all possible problems can be listed here. However, most of the normal problems encountered with the controller can be found in the list below, only return the controller to seller when you are absolutely sure that none of the problems listed below is responsible for the fault.

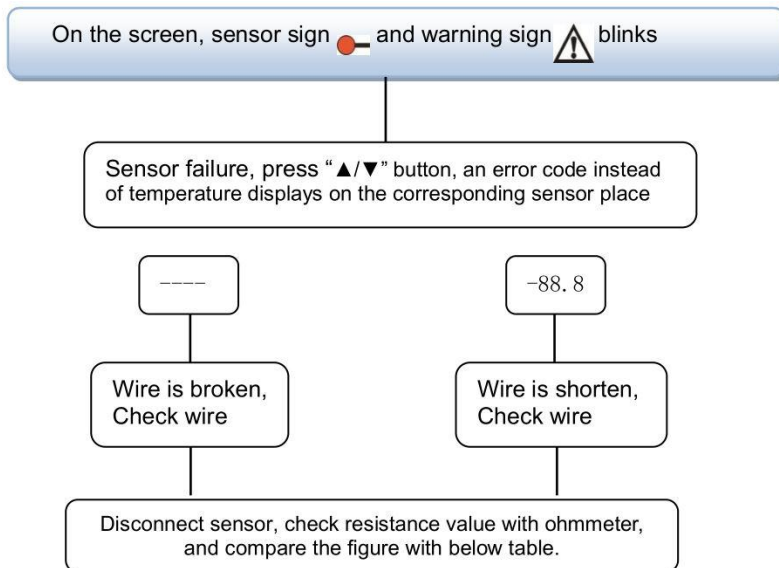

PT1000 resistance value

℃	0	10	20	30	40	50	60	70	80	90	100	110	120
Ω	1000	1039	1077	1116	1155	1194	1232	1270	1309	1347	1385	1422	1460

NTC 10K B=3950 resistance value

℃	0	10	20	30	40	50	60	70	80	90	100	110	120
Ω	33620	20174	12535	8037	5301	3588	2486	1759	1270	933	697	529	407

Error Code Explanation





Error code	Meaning	Reasons and solution
SMAX---/T3--- alternately displays	Sensor of tank maximum temperature (SMAX) is set to T3 or sensor fault	<ol style="list-style-type: none"> 1. Under main menu (load)to select T2 sensor used for the tank maximum temperature function(SMAX) 2. T3 on upper part of tank is not installed 3. T3 sensor is damaged.
AH---/T3--- alternately displays	Sensor of heating object (AHS)is set to T3 or sensor fault	<ol style="list-style-type: none"> 1. Under main menu (AH) to select sensor T2 used for the objective sensor. 2. T3 on upper part of tank is not installed 3. T3 sensor is damaged.

9. Quality Guarantee

Manufacturer provides following quality responsibilities to end-users: within the period of quality responsibilities, manufacturer will exclude the failure caused by production and material selection. A correct installation will not lead to failure. When a user takes incorrect handling way, incorrect installation, improper or crude handling, and wrong connection of Warm water outflow upwards?

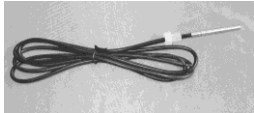
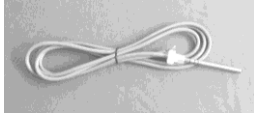
The quality warranty expires within 18 months after the date of purchasing the controller.

10. Accessories

Products name	Specification	Products picture
A01: High accurate Pt1000 sensor for collector	PT1000, $\Phi 6 \times 50\text{mm}$	
A02 High accurate sensor for tank and pipe	NTC10K, B=3950, $\Phi 6 \times 50\text{mm}$	
A05 304 stainless steel thermo well	304 stainless steel with thread 1/2' OT, Size: $\Phi 8 \times 200$	
WIFI To 485 Mode	Input: AC100-240V Output: DC5V/1A Current: 50mA Baud rate: 9600bit/s	
SR802 Unit for high power electrical heater	Dimension: 100mm*100mm*65mm Power supply: AC180V ~ 264V, 50/60Hz Suitable power: $\leq 4000\text{W}$ Available ambient temperature: $-10 \sim 50^{\circ}\text{C}$ Waterproof grade: IP43	

- **SR802 connection diagram**

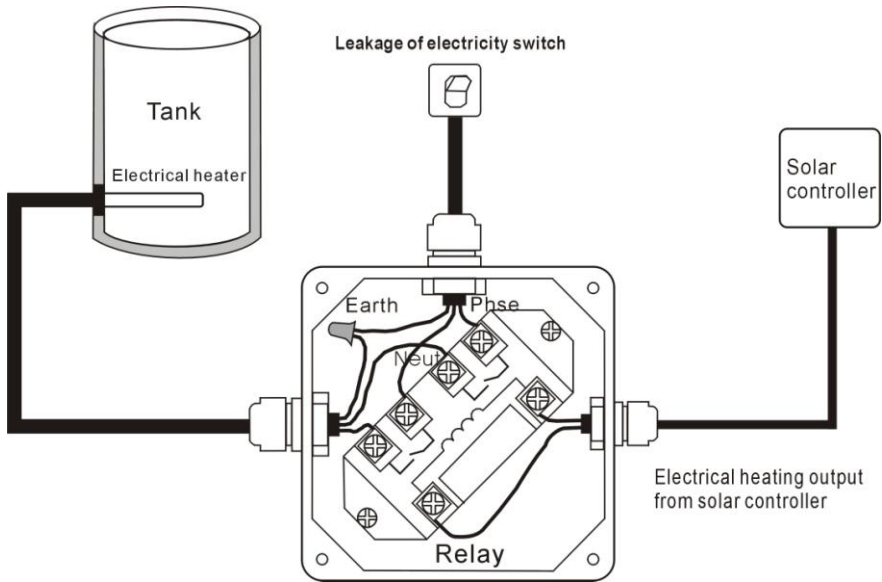

Note: Switch-off power, and perform by profession installer.